



# THE AMAZING ADVENTURES OF FERRIS STEELE



**cansmart**

steel can recycling campaign

64

## FINISH

63 Your family all put recycling in the wrong bin.

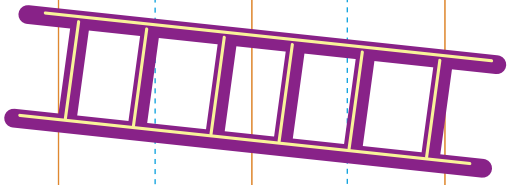
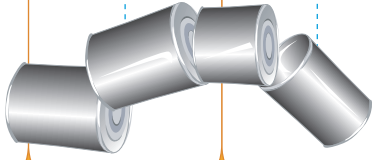

37 Started recycling program at school.

62

51

48

37

61

52

47 You and your mum didn't check for recycling pictures before buying stuff at the shops.

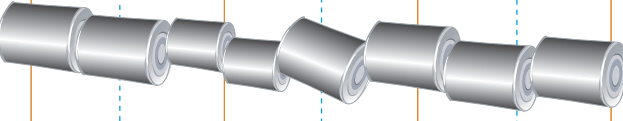

38

33

24

19

10

5 "Go back to the start because your empty can was not recycled"



60

Mum didn't squeeze the can top for recycling.

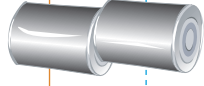

53

46

39

32

"Three steps forward because you remembered to put the crate out on recycling day"



25

18

11

Recycled your soup can.

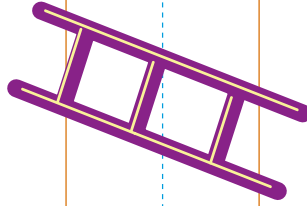

4

59

54

45

40

31

26

17

Didn't empty the steel can before recycling.

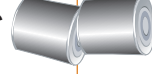

12

3

58

55

Let dad put old vegie scraps into the peach can and put in the garbage.

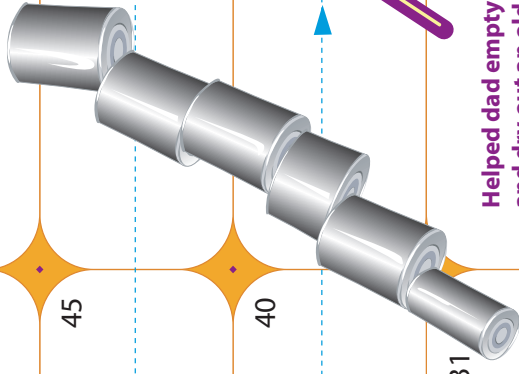

44

41

30

Helped dad empty and dry out an old paint can to recycle.

27

16

13

Mum bought a can of peaches at the supermarket.

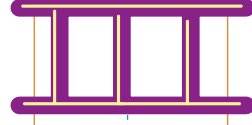

57



"You are doing well have another turn"

56

43

42

29

Threw empty aerosol cans into the garbage and didn't recycle them.

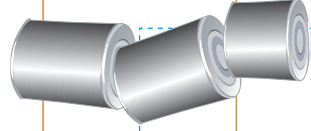

15

14

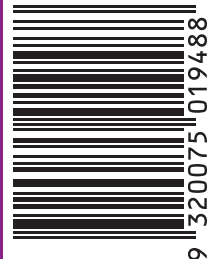

1

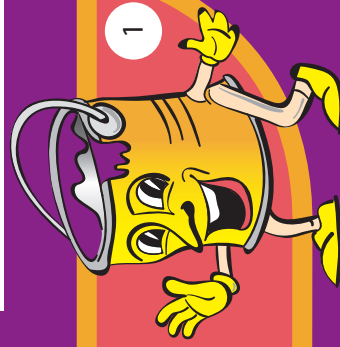

## START

22 "Lose a turn, you put my friends in the garbage"



21

8

9 Watched uncle throw an empty coffee can into the garbage and didn't tell him to recycle.

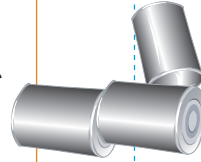

7

23

20

Put Council recycling information on the fridge.

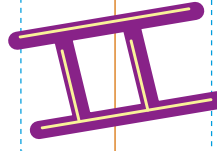

35

34